

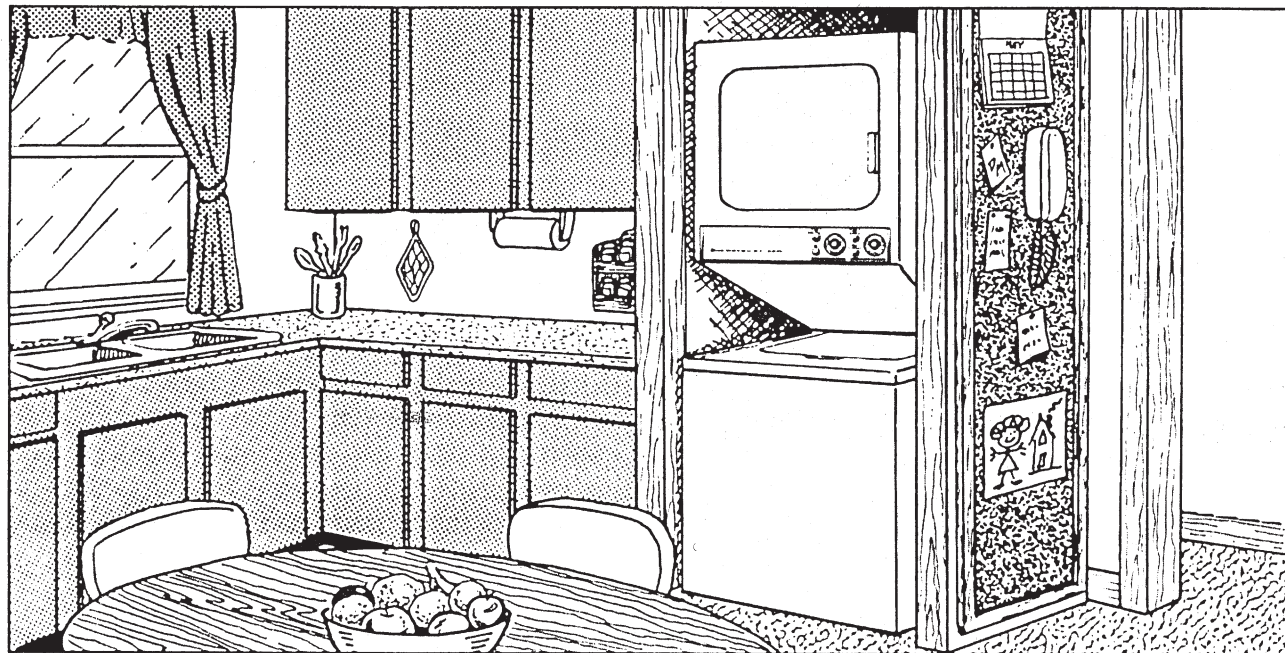

STACKED WASHER-DRYER INSTALLATION INSTRUCTIONS



LEAVE THESE INSTRUCTIONS WITH THE OWNER

IMPORTANT TO INSTALLER

REMOVE THE DOOR FROM ALL DISCARDED APPLIANCES SUCH AS DRYERS AND COMBINATION WASHER/DRYERS TO AVOID THE DANGER OF A CHILD SUFFOCATING SHOULD HE/SHE CRAWL INSIDE AND THE DOOR BE SHUT.

THE APPLIANCE MUST NOT BE INSTALLED OR STORED IN AN AREA WHERE IT WILL BE EXPOSED TO WATER AND/OR WEATHER.

U.S. MODELS

PLEASE READ THE FOLLOWING INSTRUCTIONS CAREFULLY BEFORE STARTING TO INSTALL THE DRYER. FOR GAS DRYERS, THE INSTALLATION MUST CONFORM WITH THE NATIONAL FUEL GAS CODE ANSI Z223.1, LATEST REVISION. ANY QUESTIONS CONCERNING THIS SHOULD BE REFERRED TO THE LOCAL GAS UTILITY.

CANADIAN MODELS

PLEASE READ THE FOLLOWING INSTRUCTIONS CAREFULLY BEFORE STARTING TO INSTALL THE DRYER. FOR GAS DRYER INSTALLATION, REFER TO STANDARD CAN/CGA B149 (.1 OR .2) INSTALLATION CODE. ANY QUESTIONS SHOULD BE REFERRED TO THE LOCAL GAS UTILITY.

This folder contains information of interest to the owner. After the appliance has been properly installed, LEAVE THESE INSTRUCTIONS WITH THE OWNER.

NOTICE:
SERVICE CALLS PERFORMED
AS A RESULT OF POOR
INSTALLATION ARE THE
RESPONSIBILITY OF THE
INSTALLER.

IMPORTANT TO OWNER

Retain these instructions for future reference.

This new Maytag appliance is designed to serve you dependably for many years. However, it cannot do so unless provided with sufficient electrical power, suitable exhausting and if a gas model, adequate gas supply. We urge you to read this carefully to make sure all requirements are met.

Operating instructions, safety precautions and your warranty are in the accessory package with each appliance. Read the operating instructions carefully.

NOTE: A wiring diagram for the dryer is located on the inside of the dryer access panel. A wiring diagram for the washer is located on the inside of the washer cabinet.

UNCRATING

To remove carton, cut around bottom of carton on or below dotted line. Cut down each corner of carton (vertically) and "peel" carton away from stacked washer/dryer. Fold carton material for removal. Check the unit for shipping damage.

Remove the tape between the washer cabinet and the dryer stand. Disconnect the control wire harness which leads from the dryer to the washer. You will need to depress the locking tabs to separate the connector.

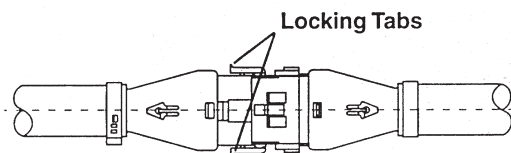

From the back of the stacked washer/dryer, grasp the dryer and stand. Pull dryer and stand back and off of washer and shipping base. As dryer and stand are pulled back, carefully drop dryer stand rear legs to the floor before clearing shipping base. (Do not drop dryer and stand off of shipping base!)

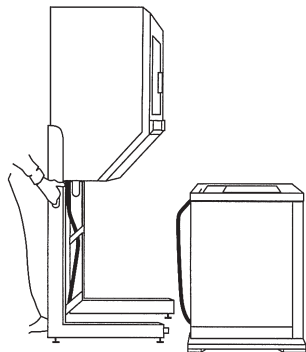

Untape and open washer lid. Remove installation accessory package, fill hoses and close lid. Leave tub block in place until installation is complete. Be sure to remove tub block after installation is complete and before use!

Using the carton corner posts stacked in pairs, lay the washer on the posts on the left side. Remove the crate base wires from the carton base. Use pliers or screwdriver to pry wires from wood. (Do not kick the shipping base off the washer.)

Run washer **rear** legs all the way up into the rear corner brackets. Lock in place by tightening lock nuts up against base. Leave front legs loose for leveling later.

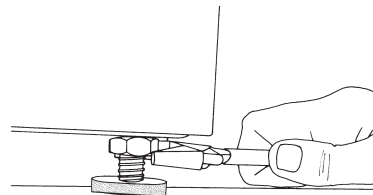

Install the vinyl feet on the washer legs.

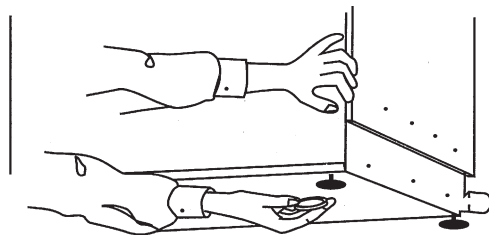

Lay a piece of the shipping cardboard along the bottom edge of the cabinet and stand the washer back up. (The cardboard protects the lower edge at the cabinet and the floor when standing the washer back up.)

NOTE: With the rear washer legs adjusted up, cabinet corner brackets in the rear can touch and damage floor if caution is not used when moving washer.

The dryer and stand are installed first. Necessary electrical, gas (if gas stacked washer/dryer) and vent connections are made as dryer and stand are put in position and leveled. Let's first look at what facilities are needed.

PREINSTALLATION CONSIDERATIONS

Location: The stacked washer/dryer is approved for zero clearance installation on the sides and the back (depending on venting used). The location selected must take into consideration the dimensions of the unit and convenience for customer use and access in case service should be needed. The floor must be capable of supporting the weight of the unit (approximately 310 lbs.) plus water (approximately 150 lbs.) and be stable

enough to prevent excessive vibration in spin cycles. A floor which is adequate for the standard washer is sufficient for the stacked washer/dryer.

The following specifications and drawings show dimensions and locations of fill valve, terminal block (electric dryer), gas inlet (gas dryer) and drain outlet.

STACKED WASHER AND DRYER

Basic Dimensions: 27¹/₂ W x 27¹/₂ D x 73 H (min.) See drawings for complete dimensions.

Uncrated Weight: Approximately 310 lbs.

KEY FACTS – WASHER

Capacity: Standard (16 gal.)

Water Usage: (full cycle)

- 36 (30 Imp.) gal.; 136 liters – large
- 28 (23 Imp.) gal.; 106 liters – medium
- 22 (18 Imp.) gal.; 83 liters – small

Motor: 1/2 H.P. rated; 120 volt; 60 Hz; reversible, thermoprotected against overload; automatic reset.

Power: .1 – .17 kwh depending on cycle

Hose Lengths: Inlet 4.0 feet, drain 4 feet

Installation Requirements: Hot and cold connections with water pressure within 20 – 120 PSI range. At least 140°F. hot water and a drain.

KEY FACTS – DRYER

Air Flow: 180CFM

Exhaust: 4" duct permits up to a maximum of 50 feet rigid aluminum ductwork. Subtract 8 feet for each 90° elbow, 8 feet for an exhaust hood. Dryer vented out the back.

Motor: 1/4 H.P. rated; 115 volt; 60 Hz thermoprotected against overload; automatic reset.

Heat Source: Electric-Nichrome helix coil, 240 volt 3-wire, 4600 watts, (4500 wats for Canadian models only), 30 amp fuse. Gas-single port burner 18000 BTU/hr.; electric ignition; automatic shut-off.

Capacity: 4.7 cu. ft., .13 cu. m.

Drum Speed: Approximately 47.5 RPM

Electrical Requirements: Electric Dryer – 240 volt 60 Hz protected by a 30 amp fuse. Gas Dryer – 115 volt electrical outlet properly grounded and protected by a 15 amp fuse.

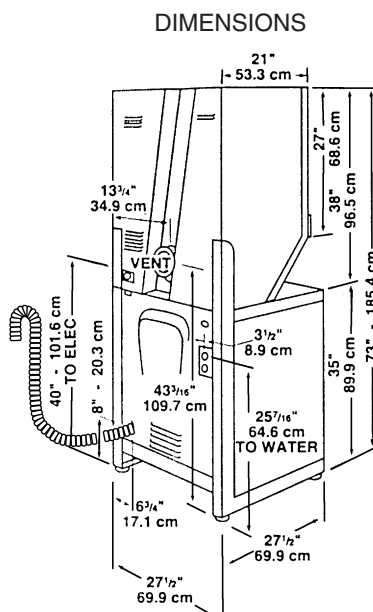

INSTALLATION SHOWING GAS DRYER CONNECTION

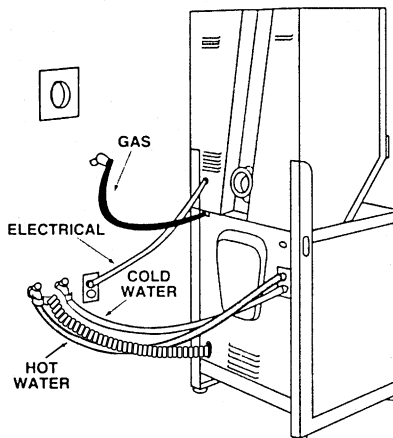

INSTALLATION SHOWING ELECTRICAL/WATER/DRAIN BOX BEHIND WASHER-ELECTRIC DRYER

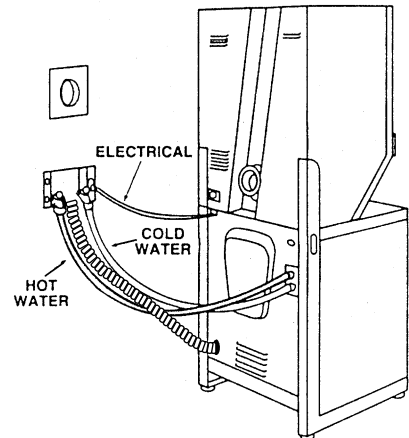

ALCOVE OR CLOSET INSTALLATION

When the stacked washer/dryer is to be installed in an alcove area or a closet, clearance should be provided around the unit for an adequate air supply and for ease of installation and servicing. An appliance installed in a closet shall have no other fuel burning appliance installed in the same closet, such as gas furnace, water heater or space heater, etc.

The dryer must be exhausted to the outside to minimize excessive lint accumulation and to maintain good drying. We recommend allowance for more clearance than the minimum installation clearances as shown.

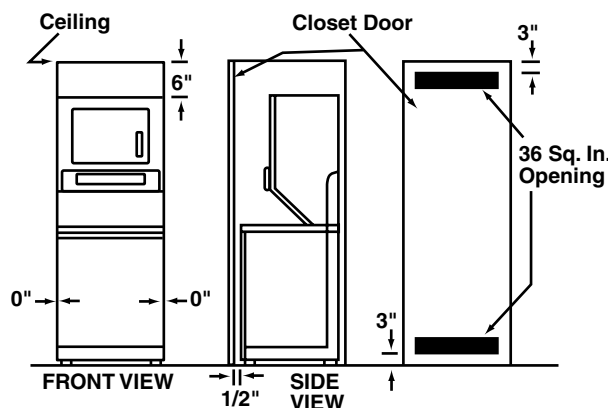

Each opening area must have a minimum of 36 square inches. These openings must not be obstructed. (Louvered door with equivalent air opening is acceptable.)

MOBILE HOME INSTALLATION

Installation of Maytag dryers certified by the American Gas Association and bearing a label stating they are suitable for installation in mobile homes, must conform to the Manufactured Home Construction and Safety Standard Title 24 CFR, Part 32-80.

When installing this appliance in a mobile home, provisions for anchoring the dryer should be made. An anchor bracket kit is available to fasten dryer stand to the floor. Instructions for installing the anchor brackets are contained in each kit. (See your authorized Maytag dealer.)

All mobile home installations must be exhausted to the outside with the exhaust duct termination securely fastened to the mobile home structure, using materials that will not support combustion.

Exhaust the dryer using metal exhausting material or exhaust kit (see your authorized Maytag dealer), and locate in an area that provides adequate make-up air. The exhaust duct may not terminate beneath the mobile home.

MAKE-UP AIR

For proper operation of the dryer unit it is important to make sure the location has adequate make-up air. This is especially important in any confined area such as bathroom or closet. There must be at least two 36 square inch unobstructed openings for intake air. This can be a louvered door or other equivalent opening.

On gas dryer units in particular, adequate clearance as noted on the dryer minimum clearance label should be maintained to insure enough air for combustion and the proper operation of the dryer. **The area where located must not obstruct the flow of combustion or ventilating air.** When installing a Maytag Stacked Washer/Dryer the following minimum clearances to combustible surfaces must be maintained. Clearance to wall, sides – 0 inches, top – 6 inches, front – 1/2 inch to washer, rear – 0 inches with an outside exhaust, 4 inches with an inside exhaust (not recommended). See Exhausting section and Installation Accessories for exhaust kits.

SERVICE ACCESS

Location should allow access to the front of the unit for washer and dryer service. Access must also be available to two screws at the top front corners of the dryer front panel (on the top).

EXHAUSTING

The free air flow rate is approximately 180 cubic feet per minute. The vent system carries lint and moisture away and to the outside. The length of the venting and the number of elbows affect the air flow rate and the efficiency of the exhaust system.

DO NOT EXHAUST DRYER INTO ANY WALL, CEILING, CRAWL SPACE OR A CONCEALED SPACE OF A BUILDING, VENT CONNECTION, GAS VENT OR CHIMNEY. THIS COULD CREATE A FIRE HAZARD FROM LINT EXPELLED BY THE DRYER. FOR THE SAME REASON, WE RECOMMEND ONLY METAL EXHAUST DUCT TO MINIMIZE RESTRICTED AIR FLOW AND RELIABLY INSURE THE CONTAINMENT OF EXHAUST AIR, HEAT AND

LINT. NEVER INSTALL A SCREEN OVER EXHAUST OUTLET. NEVER USE PLASTIC OR OTHER COMBUSTIBLE DUCTWORK. AT LEAST ONCE A YEAR, INSPECT AND CLEAN INTERIOR OF DUCTWORK. FREQUENTLY CHECK AND CLEAN VENT HOOD TO ASSURE PROPER OPERATION.

A clothes dryer produces combustible lint and the area around the clothes dryer should be kept free of lint. **DO NOT STORE FLAMMABLE LIQUIDS OR MATERIALS NEAR A DRYER.**

It is recommended that the dryer be exhausted to the outside using 4 inch rigid or flexible metal ducting.



When located in a bedroom, bathroom or closet, the dryer must be exhausted to the outside.

The stacked washer/dryer can only be exhausted out the back. A 4 inch vent should be installed to accept the exhaust from the dryer.

To permit sufficient air circulation under the exhaust hood, there should be no less than a 12 inch clearance between the bottom of the exhaust hood and the ground. When possible the exhaust hood should not exhaust directly into a window well. **DO NOT** terminate exhaust under a building.

NOTE: Where the exhaust hood is to be installed through masonry, a special masonry saw is necessary to cut the hole.

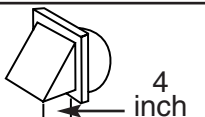
Install the exhaust hood and secure with screws to the outside wall and seal with caulking compound.

EXHAUST HOOD TYPE		
Number of 90° Turns	 4 inch	 2 1/2 inch
Maximum length of 4 inch diameter rigid metal duct		
0	54 feet	44 feet
1	43 feet	33 feet
2	36 feet	26 feet
3	30 feet	20 feet
4	24 feet	14 feet
Maximum length of 4 inch diameter flexible stiff walled metal duct		
0	34 feet	27 feet
1	26 feet	19 feet
2	22 feet	17 feet
3	18 feet	15 feet
4	15 feet	13 feet

DIRECT EXHAUST

An exhaust hood positioned to line up with the dryer exhaust pipe can be installed directly through an outside wall. This would be the shortest and most direct exhaust method.

To exhaust up, route standard 4 inch diameter ducting up the recess in the cabinet back using the furnished retaining strap and screws to get nearly flush to wall installation. To exhaust to the side or down, install the furnished 4 inch long duct with four "S" clips to the inner dryer exhaust, then use standard 4 inch ducting. This will position the dryer about 4-1/2 inches away from the wall. Flush-to-wall side exhausting may be done by going above the dryer before going sideways.

When exhausting down, wallboard can be removed from the wall to get the dryer closer to the wall by placing the exhaust pipe between studs. **Check local codes for required exhaust clearances.**

Install ductwork from the dryer to exhaust hood. All joints must be made so exhaust end of one pipe is inside the intake end of next pipe. On flexible metal ductwork, all joints should be secured with a clamp. **DO NOT** use sheet metal screws when assembling rigid ducting. Joints should be taped.

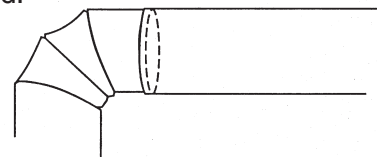

FLEXIBLE DUCTWORK LIMITATIONS

Flexible metal ductwork should not exceed 34 feet of straight 4 inch ducting. The exhaust hood is equivalent to 8 feet of duct and each 90° bend is equivalent to 8 feet. As an example, if an exhaust hood is used and two 90° bends, the maximum straight run would be 10 feet.

NOTE: If the radius of a bend with 4 inch duct is 12 inches or greater, the bend can be considered a straight run. No more than three 90° bends should be used in any run with an exhaust hood.

If flexible metal exhaust ducting is used, the short extension supplied with this machine can be secured to the dryer exhaust with the clips and the flexible metal duct can be clamped to the short extension.

RIGID DUCTWORK LIMITATIONS

Rigid metal ductwork should not exceed 54 feet of straight 4 inch duct. Each 90° elbow and the exhaust hood should be considered equivalent to 8 feet of straight ductwork.

For example, if an exhaust hood and two 90° elbows are used, the maximum straight duct allowed would be 26 feet. Not more than three 90° elbows should be used in any rigid ductwork run with an exhaust hood. Four feet of straight duct should be allowed between 90° elbows.

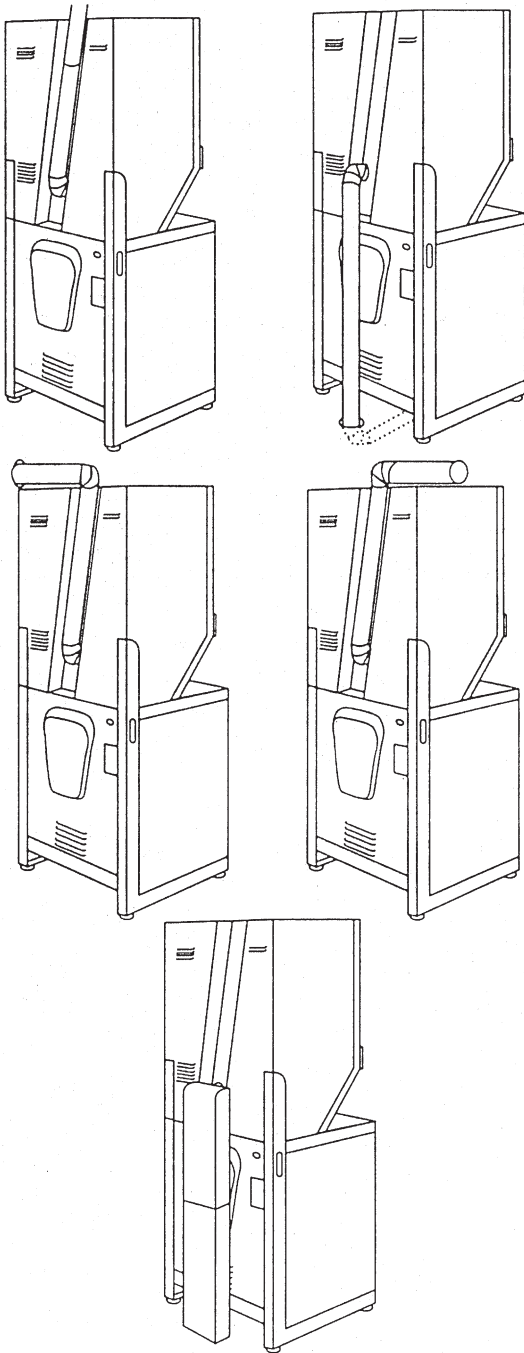

ELECTRICAL REQUIREMENTS

IMPORTANT SAFETY PRECAUTIONS

WARNING: To prevent unnecessary risk of fire, electrical shock or personal injury, all wiring and grounding must be done in accordance with local codes, or in the absence of local codes, with the National Electrical Code, ANSI/NFPA (for the United States) or the Canadian Electrical Code, CSA C22.1 (for Canada). It is the personal responsibility and obligation of the appliance owner to provide adequate electrical service for this appliance.

OBSERVE ALL NATIONAL CODES AND LOCAL CODES AND ORDINANCES

GAS DRYER UNITS

A 120 volt, 60 Hz 15 ampere fuse electrical supply is required. An individual branch (or separate) circuit serving only this appliance is recommended. **DO NOT USE AN EXTENSION CORD** unless it meets all requirements as outlined for grounding, polarizing (3-wire) and capacity. Wire size should be at least No. 14.

BEFORE OPERATING OR TESTING, follow grounding instructions in Grounding section.

ELECTRICAL GROUNDING IS REQUIRED FOR THIS APPLIANCE.

GROUNDING INSTRUCTIONS

This appliance must be grounded. In the event of malfunction or breakdown, grounding will reduce the risk of electrical shock by providing a path of least resistance for electric current. This appliance is equipped with a cord having an equipment-grounding conductor and a grounding plug. The plug must be plugged into an outlet that is properly installed and grounded in accordance with all local codes and ordinances.

DANGER – Improper connection of the equipment-grounding conductor can result in a risk of electric shock. Check with a qualified electrician or serviceman if you are in doubt as to whether the appliance is properly grounded.

Do not modify the plug provided with the appliance. If it will not fit the outlet, have a proper outlet installed by a qualified electrician.

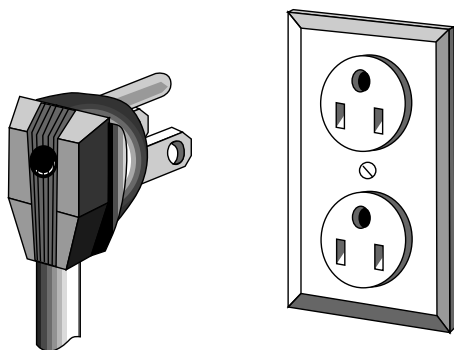

ADDITIONAL GROUND PROCEDURE WHERE LOCAL CODE PERMITS.

A grounding kit (Part No. 12001875) is available. It contains the external ground wire, clamp, ground screw and washer. Where approved, it is recommended this additional ground be installed. A suitable external ground connection **MUST** be determined prior to wire hookup. Consult local building officials and qualified electrician in event any questions exist. Connect ground wire to back of dryer unit using the grounding screw and washer. Secure other end of the ground wire to a COLD water pipe using the clamp.

NEVER CONNECT GROUND WIRE TO PLASTIC PLUMBING LINES, GAS OR HOT WATER PIPES.

ALL GROUNDING AND WIRING MUST BE DONE IN ACCORDANCE WITH NATIONAL AND LOCAL CODES.

ELECTRIC DRYER UNITS U.S. MODELS

Grounding Instructions

This electric dryer must be connected to a grounded metal, permanent wiring system; or an equipment grounding conductor must be run with the circuit conductors and connected to the equipment grounding terminal on the back panel.

Electric models are shipped with a ground strap connected from the neutral (P2) terminal block post to the frame of the dryer. The use of this strap is permitted by the national electrical code. The dryer electrical supply may be connected by means of a new U.L. listed power supply cord kit rated at 240 volts minimum, 30 amperes with three No. 10 copper wire conductors terminated with closed loop terminals, open-end spade lugs with turned up ends or with tinned leads.

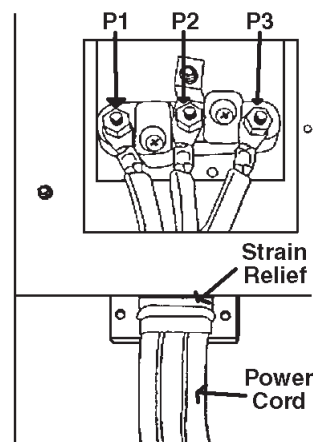

The power cord must be marked for use with a clothes dryer and be retained with suitable strain relief. If the dryer is to be installed in a mobile home or an area where local codes do not permit grounding through neutral, only 4 conductor power cord, rated and terminated as above, may be used.

The electrical supply circuit should be fused through a 30 ampere fuse or circuit breaker on both sides of the line. The neutral line of the service cord must always be connected to the P2 terminal post. The two hot lines of the service cord go to the P1 and P3 terminal block posts. The neutral should not be fused or broken. Be sure terminal block nuts are tight and replace access cover.

Canadian models are shipped with approved power cord sets attached.

G.F.I.

If the electric dryer is protected by a GROUND FAULT INTERRUPTER, follow the procedure on the next page for a 4-wire hook-up.

4-WIRE RECEPTACLE

For a 4-wire hook-up, the frame of a 120/240 volt machine must NOT be connected to neutral terminals. It MUST be connected to the 4th wire (green) of the power supply or to the metallic covering of a 3-wire supply.

If a 4-wire receptacle of NEMA type is used, a matching U.L. listed power supply cord (pigtail) must be used. This cord contains four No. 10 copper conductors with spade or ring terminals on the dryer end. The 4th (grounding) conductor must be identified by a green cover and the neutral conductor by a white cover. The cord should have a suitable strain relief, and should be a minimum 4 feet long. The power supply cord and strain relief are not provided with the dryer.

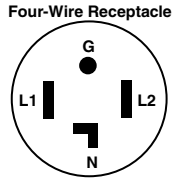

4-WIRE SYSTEM CONNECTIONS

1. Remove the terminal block cover.
2. Remove the ground strap screw from the terminal block support. Fold the ground strap over so both ends of the ground strap are attached to the center terminal block post.
3. Connect the neutral (white) wire of the power supply cord to the center (silver colored) terminal of the terminal block. Connect the grounding (green) wire of the cord to the terminal block support using the ground strap screw.

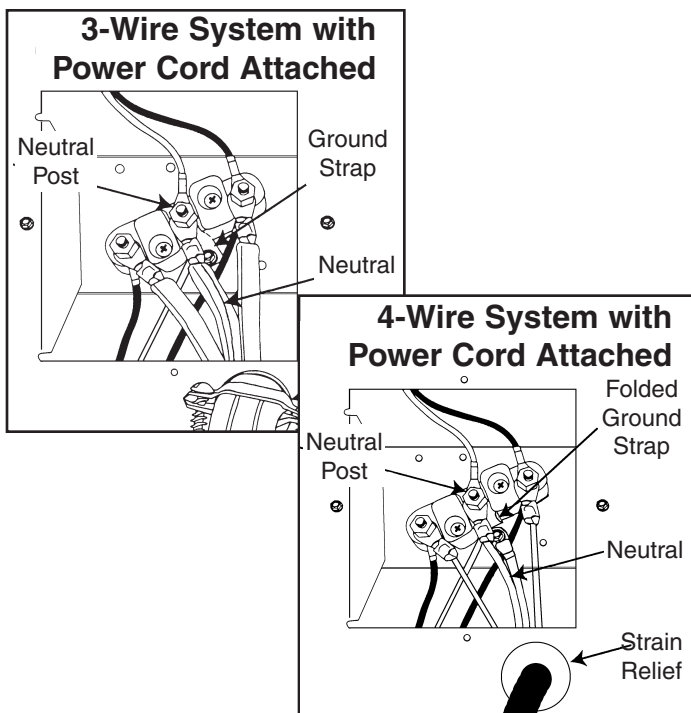

4. Connect the other two wires of the cord to the outer terminals of the terminal block.
5. Replace the terminal block cover.

208 VOLT OPERATION

A stacked washer/dryer model is available for 208 volt operation.

Canadian Models

All Canadian models are shipped with the power cord attached. The dryer power cord should be plugged into a 30 ampere receptacle and fused through a 30 ampere fuse or comparable circuit breaker on both sides of the line.

NOTE: It is not permissible to convert a dryer in Canada to 208 volts. A 208 volt model is not available for Canada.

WATER SUPPLY AND DRAIN

WATER SUPPLY

The water supply to the washer unit should be capable of providing both adequate water pressure and water temperature. The pressure should fall within the range of 20 pounds per square inch to 120 pounds per square inch when the washer is filling. Note that this is flow pressure and not static pressure. Low water pressure will result in slow fill and could result in a water valve sticking open after a fill.

The recommended temperature of the hot water as delivered to the washer should be 140° F.

Warm water temperature is a result of the mix of the hot and cold water supplies. The final temperature is dependent on both the pressure and the temperatures of the hot and cold supplies. The desired temperature for warm is between 100° F. and 105° F.

DRAIN FACILITIES

The drain must be capable of accepting a flow rate of approximately 20 gallons per minute. An inside diameter of at least 1 1/2 inches is required.

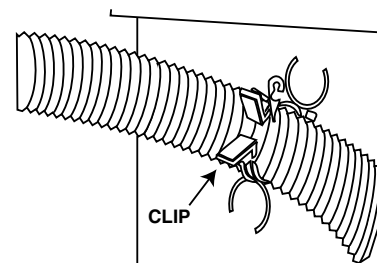

36 inch standpipe recommended

If standpipe is less than 36 inches (or floor drain) – drain hose should be routed through the clip to raise hose to the proper height, use clip tie to securely hold drain hose in clip.

Installation accessory kits are available for other types of drain facility conditions...see Washer Installation Accessory Kits table on page 13.

The use of a laundry built-in wall box can greatly simplify installation.

If the faucets and/or drain is located to either side of the stacked washer/dryer, openings are located in the dryer stand uprights to allow hoses and power cords to be passed through. This is to allow installation against the back wall. (This is dependent on venting used.)

GAS CONNECTION

Gas operated dryers are equipped with a burner orifice for operation on NATURAL GAS. If the dryer is to be operated on LP GAS, it must be converted correctly for safety and proper performance. Conversion kits from NATURAL to LPG, or LPG to NATURAL are available through your local Maytag dealer. If other conversions are required, check with local gas utility for specific information concerning conversion requirement. **NOTE: The conversion should always be performed by a qualified service technician.**

NOTE: If the dryer is to be converted in Canada, the conversion shall be carried out in accordance with the requirements of the provincial authorities having jurisdiction and in accordance with the requirements of the CAN-B149.1 and CAN1-B149.2 installation code.

A 1/2 inch gas supply line is recommended and must be reduced to connect to the 3/8 inch gas line on the dryer.

IMPORTANT NOTE: When installing the gas line, route it so that it will not interfere with the washer once the washer is pushed back into position. It is important to make sure the gas line does not come into contact with either the washer drain hose or any part of the washer.

NOTE: A 3/8 inch x 1 inch pipe nipple is included to adapt valve connection from a 3/8 inch female to a 3/8 inch male I.P.S. connection.

Additionally, a 1/8 inch N.P.T. (National Pipe Thread) plugged tapping, accessible for test gauge connection, must be installed immediately upstream of the gas supply connection to the dryer.

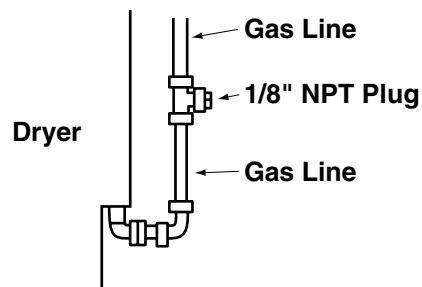

Refer to your local gas utility or plumbing contractor should you have questions on the installation of the plugged tapping.

The dryer and its individual shut-off valve must be disconnected from the gas supply piping system during any pressure testing of the system at test pressures in excess of 1/2 P.S.I.G.

The dryer must be isolated from the gas supply piping system by closing its individual manual shut-off valve during any pressure testing of the gas supply piping system at test pressures equal to or less than 1/2 P.S.I.G.

The gas supply should be connected to the dryer using pipe joint compound or a Teflon tape on male thread connections. **NOTE:** Any pipe joint compound used must be resistant to the action of any liquefied petroleum gas.

Turn on gas supply and open the shut-off at the gas valve. **DO NOT use an open flame to check for gas leaks.** Check all gas connections for leaks using a soap solution. If bubbles occur, tighten the connections and recheck.

NOTE: As a courtesy, many local gas utilities will inspect a gas appliance installation. Check with your utility to see if this service is provided in your area.

GAS IGNITION

This dryer uses an automatic ignition system to light the main burner when the dryer is turned on.

INSTALLATION

INSTALL DRYER UNIT AND STAND

The dryer and stand are installed first. With the connections prepared for exhausting, electric power and gas (if gas stacked washer/dryer, see page 9), the dryer and stand are moved to the location.

NOTE: When moving the dryer and stand on an appliance hand truck, it is recommended that the dryer and stand be trucked upside down. Protective padding should be used to avoid damage to the cabinet finish.

1. Grasp the dryer and stand. Pull away from washer and off of shipping base. Install vinyl feet; in Accessory Package located in Washer. Move dryer and stand to location. Level by adjusting leveling legs.

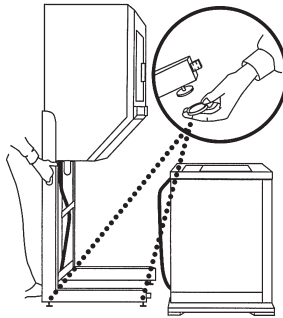

NOTE: The rear legs are “washer” legs and use the larger feet.

2. **GAS MODELS -** Connect gas line using pipe joint compound on male threads, see page 9 for GAS CONNECTION.

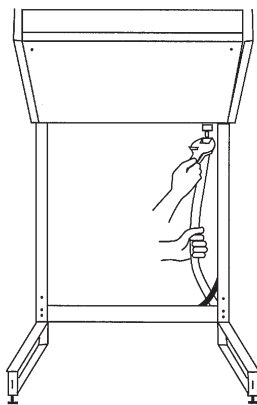

ELECTRIC MODELS - Install electric power cord (U.L. Approved). **NOTE:** Power cord provided with Canadian models.

Make appropriate external ground connection.

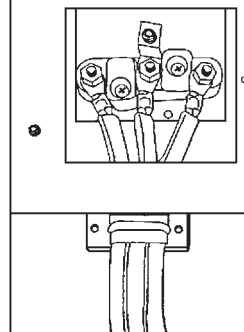

See DETAILED Installation Instructions for ELECTRICAL REQUIREMENTS AND GROUNDING (pages 6-7).

3. Make exhaust connections. Exhaust connection is lined up as the dryer and stand are moved back into position.

See DETAILED Installation Instructions for EXHAUSTING (pages 4-6).

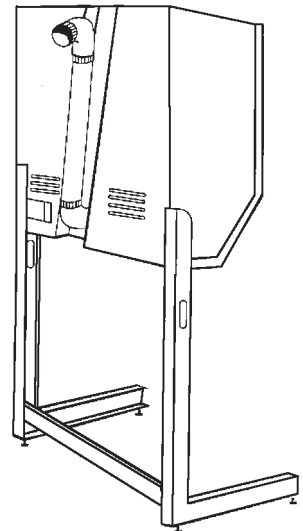

4. Adjust stand and dryer into proper location. **Check stand to make sure unit is still level.** Level legs and rear lower cross bar. Tighten lock nuts up against the stand.

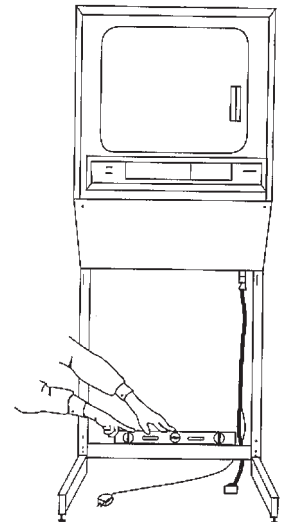
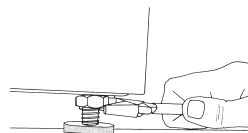

With dryer and stand in position, exhaust vent connected, unit leveled and gas line connected (if gas unit), power cord set installed (if electric unit), plug power cord into electric outlet.

DRYER INSTALLATION ACCESSORIES

Vent Kit – standard – 4" (10.16cm)
kit includes two elbows, three pipes and one vent hood

Vent Hood – 4" (10.16cm) opening

Aluminum Pipe – 4" x 24" (10.16cm x 60.96cm)

Aluminum Elbow – 4" (10.16cm)

Aluminum Window Plate – 15" x 20"
(38.10cm x 50.80cm) – 4" (10.16cm)

Flexible Vent Kit – contains wide opening vent hood, wall plate, two clamps and flexible aluminum vent duct

Flexible Aluminum Vent Duct – 4" (10.16cm) diameter – 38" (81.28cm) length stretches to 8' (2.44m)

Clamp for Flexible Aluminum Duct

Exhaust Deflector Kit – inside exhaust kit

Natural to LPG Conversion Kit for Gas Valve

Dacron Lint Bag

Grounding Kit – contains ground wire, clamp, ground screw and washer
(Part No. 12001875)

INSTALL WASHER UNIT

1. Remove top cover shipping pads taped to washer top.

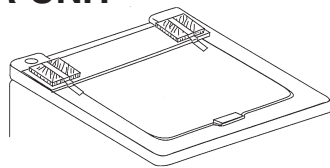

2. Remove fill hoses. Replace and leave tub block in place until installation is complete. Close lid.

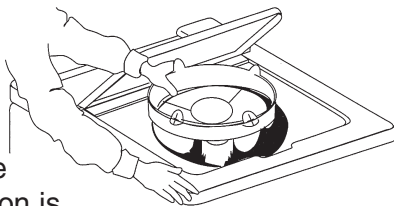

3. Remove the crate base wires from crate base. Use pliers or screwdriver to pry from wood. Discard crate base.

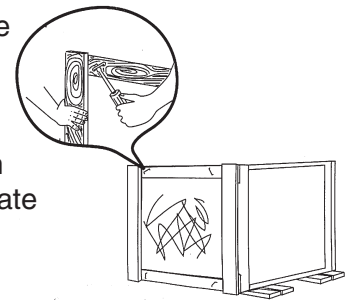

4. Run washer rear legs all the way up into the rear corner brackets. Lock in place by tightening lock nuts up against base. Leave front legs loose for leveling later.

Install the vinyl feet on the front washer legs.

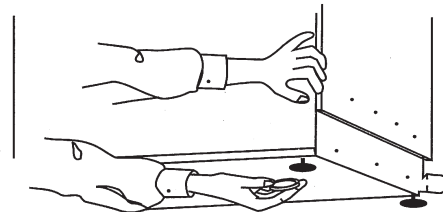

5. Move the washer into position in front of the dryer and stand. **Use caution** to avoid floor damage because of the minimum height of the rear legs.

NOTE: Before sliding washer back into position, connect fill hoses and insert drain hose in standpipe.

6. Install inlet hoses.

Run water through both water faucets into a bucket to purge the water line particles that might clog the hoses. While running water through the faucets, determine which faucet is HOT water and place an identifying mark on it. Traditionally the HOT water faucet is on the left.

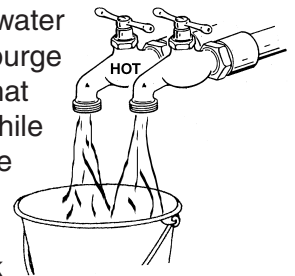

Insert one screen and then one washer into the faucet ends of the inlet hoses (straight end of hoses). The screens should be pointing out to fit properly.

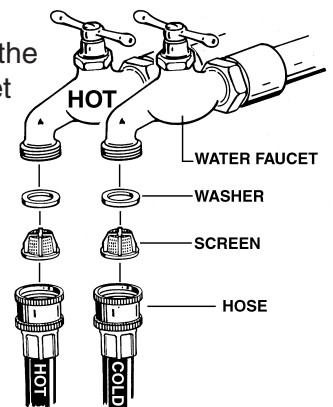

Attach the inlet hoses to the HOT and COLD faucets. Being sure the hose marked "HOT" is attached to the HOT water faucet. Tighten by hand until snug and then 2/3 of a turn with pliers. **Do not overtighten.**

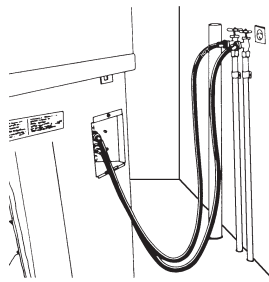

Attach the 90° ends of the inlet hoses to the HOT and COLD connections on the back of the washer. HOT and COLD connections are identified by H & C stamped on the bracket, HOT on top, COLD on bottom. Connect COLD (lower) hose first. Be sure the hose marked "COLD" is attached to the COLD ("C") connection. Tighten by hand until snug and then 2/3 of a turn with pliers. **Do not overtighten.**

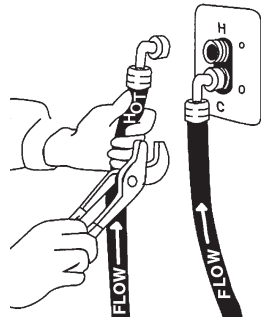

Turn on faucets and check for leaks at the faucets and at the machine connections. If leak occurs, check for cross-threaded or loose connections.

7. Install drain hose.

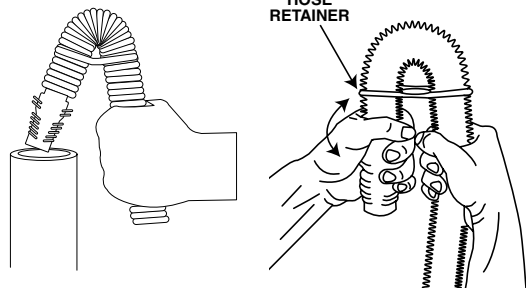

Place the drain hose in the drain facility. If the hose is twisted after it has been placed in the drain, adjust the end of the hose to remove the twist. To remove the twist, turn the short end of the hose while holding the base of the hose stationary.

NOTE: If you must make an airtight seal, an siphon break kit must be used.

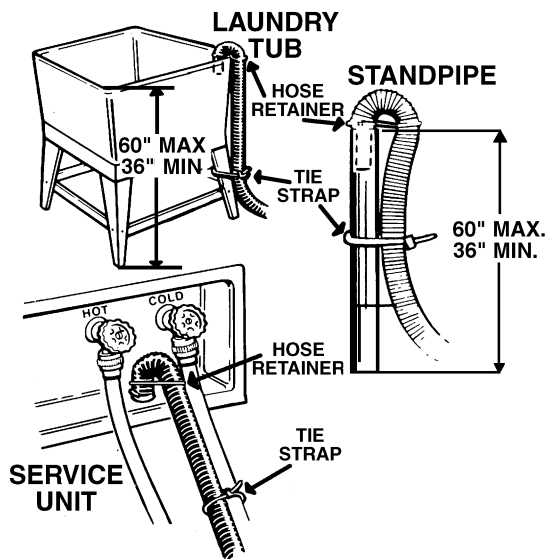

To prevent accidental dislodging secure the drain hose to the standpipe, inlet hose or laundry tub with the tie strap provided in the parts package.

NOTE: It is very important when connecting the drain hose that it is properly installed to minimize the chance of the hose becoming damaged when the washer is moved into position.

8. Move the washer into position in front of the dryer and stand. Tip forward enough for glides to clear the legs of the stand and guide the glides into the slots on the top of the stand legs.

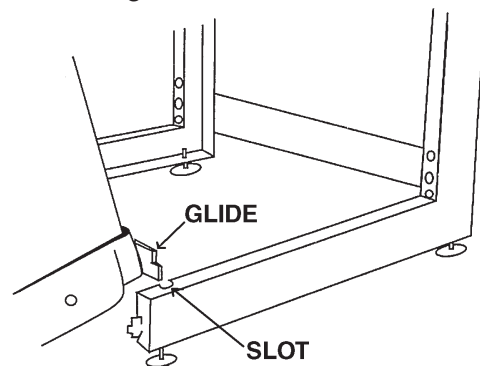

9. Connect the two control cables, one from the dryer and one from the washer, as shown. Be sure the locking tabs are engaged. This electrically mates the washer and dryer.

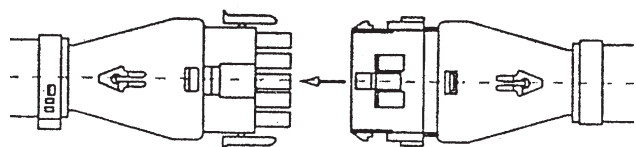

- 10.** Connect the dryer power cord to 120 volt AC outlet for gas models. 240 volt outlet for electric models.

Make appropriate external ground connection. See DETAILED Installation Instructions for ELECTRICAL REQUIREMENTS AND GROUNDING (pages 6-7).

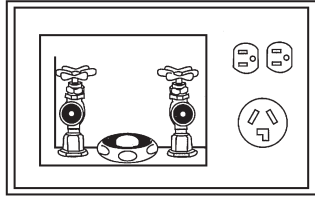

- 11.** Slide washer all the way back into stand. Tabs on stand legs are to slide into the washer front panel. Adjust the washer front legs. Level washer on stand. Lock leveling legs in position using lock nuts.

It is very IMPORTANT that the washer sits in the stand properly. Unit must be solid and level.

Check unit to finish leveling. Be sure to lock ALL leveling leg lock nuts.

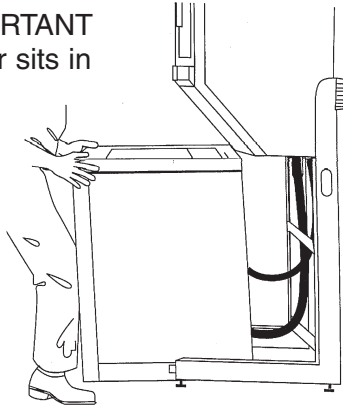

- 12.**
- Remove tub block ring from washer tub opening.
 - Verify that all instruction packages have been removed from washer tub and dryer drum.
 - See Installation Checklists for washer and dryer.

DRYER INSTALLATION CHECK LIST

- Dryer is plugged into electrical outlet and is properly grounded.
- Exhaust duct work is hooked up and joints taped.
- Plastic flexible duct is NOT used.
- Use rigid or stiff-walled flexible metal vent material.
- Dryer is level with all legs firmly on the floor, with the lock nuts tightened.
- Vinyl feet have been installed.
- Gas Models – gas is turned on, there are no gas leaks.
- Dryer runs, heats, shuts off.
- Demonstrate use to consumer.

WASHER INSTALLATION CHECK LIST

- Tub block, parts package and instructions have been removed from the tub.
- Water has been turned on. Checked for leaks at faucets and water valve connections.
- Drain hose is properly located into drain facility and is not damaged.
- Washer has been leveled with legs firmly on the floor. The front leveling legs' locking nuts have been tightened.
- Fill washer, checking for the correct water temperature.
- After the washer has filled, let the washer agitate.
- Spin the water out.
- Demonstrate washer usage to consumer. Be sure to leave these instructions and the User's Guide with the owner.

WASHER INSTALLATION ACCESSORY KITS

Part No.	Description	Application
12001875	Grounding Kit	Contains ground wire, clamp, ground screw and washer.
12001585	Drain Hose Extension	Extends drain hose for drain facilities higher than 1.2 m (4 ft.).
12001586	Siphon Break	Used when an air-tight connection exists between drain hose and drain facility. Floor drain facilities.
12001599	Small Diameter Standpipe Drain Hose	Used when standpipe diameter is too small to receive end of drain hose.
211692	Non-Slip Disc	For painted /sloped floors.
204986	Carpet Installation Disc	For carpeted floors.

ADDITIONAL INFORMATION

ODD CYCLE OPERATION

This Maytag stacked washer/dryer is manufactured for operation on 60 Hz approved electrical service. It is not designed for use on 50 Hz AC electrical service and conversion of the product from 60 to 50 cycle operation is not recommended. For additional information on 50 cycle products, write, MAYTAG INTERNATIONAL, INC., 8700 Bryn Mawr Ave., Chicago, Illinois 60631 or GRAY DISTRIBUTING CO., LTD., P.O. Box 2597, Honolulu, Hawaii 96803.

LUBRICATION

No routine lubrication is required to maintain the stacked washer/dryer. In the event something does need attention, contact an authorized Maytag dealer or servicer.

FINISH

All the cabinetry and external finishes are protected against rust to keep product looking well for many years. Cleaning and waxing will provide additional protection to these finishes.

The washer top has a porcelain finish. Since porcelain is "glass" bonded to metal, it is very durable. Avoid damage from sharp blows of objects or tools used around and in the appliance.

Clean the control panel with a soft damp cloth. Avoid abrasive cleaners that would scratch surface. A coat of household wax will reduce the chance of scratches on the control panel surface.

CAUTION: If "spilled" or used improperly, bleaches and other strong laundering chemicals can permanently spot or stain finishes unless wiped up immediately. Aerosol pretreated products can also damage finish on control panel. When using these products on garments placed in the stacked washer/dryer, it is advisable to avoid control panel area with the overspray.

WATER DAMAGE FROM FLOODING

In the event the stacked washer/dryer is exposed to water from flooding, call your local Maytag dealer before using. Always unplug the appliance and have a qualified technician inspect the appliance before any attempt is made to operate the unit. Never wash product inside and out with a garden hose or pressure cleaning system.

REPLACEMENT PARTS

If your unit requires replacement parts, contact the dealer from whom you purchased your appliance, or Maytag Appliance Sales Co., Customer Service Division, Box 2370, Cleveland, Tennessee, 37320-2370, phone 1-800-688-9900, for information on the nearest Maytag part distributor.

Part and service manuals are available through your dealer or nearest parts distributor.